

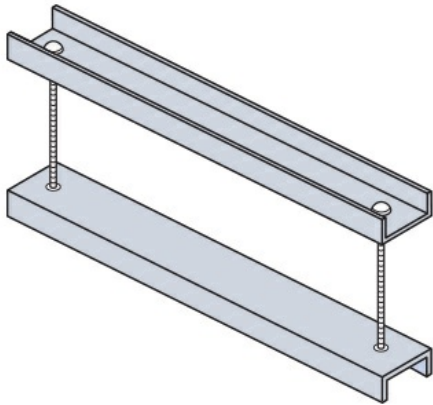

**Cablofil**  
**Flat Cover Connectors Channel-Style**  
Part No. P645057



The aluminum I-beam design of ITray is perfect for industrial installations with large diameter cables in long span situations, minimizing total tray width and creating a smooth transition between straight sections and fittings. A structural offset in the sidewall creates strong, mid-span splices that need fewer supports. Each splice snaps in place and stays without holding. Additionally, only four bolts are needed for each splice reducing hardware needs by 50%. These features allow Itray to be installed up to 30% faster than standard tray.

## Features & Benefits

For use with indoor, outdoor, or vertical flat covers.

Top and bottom pieces are 1 1/2" wide.

## Specifications

### General Info

Product Line	Cablofil	Finish	Hot Dipped Galvanized
UPC Number	800388534469	Country Of Origin	Mexico

### Dimensions

Product Width US	31.625 in	Product Weight US	2.836 lb
Product Volume US	0.058 cu ft	Product Depth US	1.5 in
Product Height US	2.11 in		

### Buy American Act Compliance

BAA	Yes
-----	-----